

Cat. No. 15-1992  
OWNER'S MANUAL

## 4-in-One Light-Up Remote Control

Please read before using this equipment.

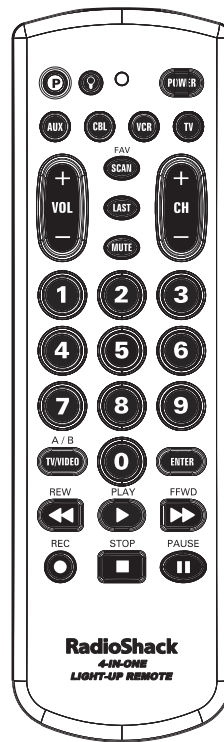

**RadioShack®**

## FEATURES

---

Your RadioShack 4-in-One Light-Up Remote Control can replace up to four infrared remote controls. Use it to control your TV, VCR, TV/VCR combination, cable converter, CD player and more.

Unlike some universal remote controls, your 4-in-One Light-Up has a lighted keypad that lets you easily see the remote's buttons in a dark room. When you turn on the feature, pressing any button lights the entire keypad.

This manual includes a list of many manufacturers' 4-digit codes for TVs, VCRs, cable converters, CD players, and more.

Your remote control's features include:

**Powerful Infrared Beam** — lets you operate your remote-controlled devices from a greater distance than many of the original remote controls.

**Large, Easy-to-Use Keypad** — with buttons in the ideal positions for easy operation.

**Handy Reference Label** — provides a convenient place for you to write down the manufacturers' codes for your devices.

**Toll Free Support** — brings expert help for your remote control directly to you when you call **1-888-284-8735**.

**Note:** You need four AAA batteries (not supplied) to power your 4-in-One Light-Up Remote Control.

© 1999 Tandy Corporation.  
All Rights Reserved.  
RadioShack is a registered trademark used by  
Tandy Corporation

# CONTENTS

---

---

<b>Introduction .....</b>	<b>4</b>
<b>Preparation .....</b>	<b>5</b>
Installing Batteries .....	5
Device Types .....	6
Setting Up Your Remote Control .....	6
To Operate Your TV/VCR Combination ..	7
<b>Operation .....</b>	<b>8</b>
Converting Device Keys .....	8
Punch-Through .....	9
Turning Punch-Through Off /On .....	9
Favorite Channel Scan .....	10
Clearing Favorite Channel Scan ...	11
Using the Light .....	11
<b>If You Have Problems .....</b>	<b>12</b>
Manual Code Search .....	12
Determining the 4-Digit Code .....	13
Troubleshooting .....	14
<b>Manufacturer Codes .....</b>	<b>15</b>
Cable Converters .....	15
CD Players .....	17
Home Automation .....	20
Video Accessories .....	20
Satellite Receivers .....	20
Televisions .....	21
VCRs .....	28
TV/VCR Combinations .....	34
<b>Care .....</b>	<b>36</b>
<b>Specifications .....</b>	<b>37</b>

## INTRODUCTION

Your RadioShack 4-in-One Light-Up was designed to control the most commonly used functions on your TV, VCR, TV/VCR combination, cable converter, and CD player. It might not be able to duplicate some of your original remote control's seldom-used functions.

When you set up the 4-in-One, its command keys work like the keys on your original remote controls. For example, the 4-in-One's **POWER** key works like a **POWER ON/OFF** key on your original remote control.

Key	Function
<b>P</b>	Used to set up devices
	Used to light the keypad
<b>POWER, VOL +, VOL -, LAST, MUTE, CH +, CH -, digit keys, TV/VIDEO, ENTER</b>	Operate the same as the corresponding keys on your original remote control
<b>AUX, CBL, VCR, TV</b>	Used to set up the remote control to replace original remote controls. Also used in normal operation to tell the remote control which device to control.
<b>FAV/SCAN</b>	Can be programmed to allow immediate access to your 10 favorite channels, or left unprogrammed to scan all channels
<b>REW ◀, PLAY ▶, FFWD ▶▶, REC ●, STOP ■, PAUSE ■■</b>	Control VCR functions

**Note:** To record, you must press **REC ●** twice. This helps avoid accidentally recording over tapes.

## PREPARATION

---

### INSTALLING BATTERIES

Your remote control requires four AAA batteries (not supplied) for power. For the best performance and longest life, we recommend RadioShack alkaline batteries.

**Cautions:**

- Use only fresh batteries of the required size and recommended type.
- Do not mix old and new batteries or different types of batteries.
- Do not press any of the remote control's keys while installing batteries.

**Note:** The 4-in-One's built-in memory backup saves any programmed codes for about 10 minutes after the batteries have been removed. We recommend you have fresh batteries ready to install as soon as you remove the old ones.

1. Press the battery compartment cover's tab and lift off the cover.
2. Place the batteries in the compartment as indicated by the polarity symbols (+ and -) marked inside.
3. Replace the cover.

When the 4-in-One's range decreases or it stops operating properly, replace the batteries.

**Caution:** Always remove old or weak batteries. Batteries can leak chemicals that can destroy electronic parts.

**Warning:** Dispose of old batteries promptly and properly. Do not burn or bury them.

---

**Note:** Do not place objects on top of the remote control after you have installed the batteries. This can press keys for an extended period of time and reduce the battery life.

## DEVICE TYPES

You can use the remote control's device keys to control the following types of devices:

- TV** — TVs
- VCR** — VCRs and TV/VCR combinations
- CBL** — Cable converters, satellite systems
- AUX** — CD Players, Home Automation

## SETTING UP YOUR REMOTE CONTROL

1. Refer to "Manufacturer Codes" on Page 15 and write down the codes for your brand of device on the 4-in-One's label.

**Note:** Some manufacturers have several codes. Try each until you find the right one. See "If You Have Problems" on Page 12 if you cannot find the correct code.

2. Press the device key for the type of remote you are replacing (**TV**, **VCR**, **CBL**, or **AUX**). The red light blinks.
3. Hold down **P** until the red light blinks twice, then enter the 4-digit manufacturer's code.

For example, to replace a Panasonic TV's remote control (manufacturer's code 0051), press **TV**, hold down **P** until the red light blinks twice, then press **0 0 5 1**.

When the red light blinks twice, the remote control has accepted the code.

**Note:** If the code you entered is invalid, the red light blinks.

---

- 
4. Point the remote control at your device and press **POWER**. Your device should turn off (or on, if it was off).

If the remote does not operate your device, try the other codes listed in "Manufacturer Codes" on Page 15 for your brand of device.

5. Repeat Steps 2–4 for additional devices.

## TO OPERATE YOUR TV/VCR COMBINATION

1. Locate the codes for your TV/VCR combination in "TV/VCR Combinations" on Page 34 and write them on the 4-in-One's label.
2. Press **VCR**. The red light blinks.
3. Hold down **P** until the red light blinks twice, then enter the 4-digit manufacturer's code. When the red light blinks twice again, the remote control has accepted the code.

**Note:** If the code you entered is invalid, the red light blinks.

4. Point the remote control at your TV/VCR combination and press **POWER**. Your device should turn off (or on, if it was off).

If the remote does not operate your device, try the other codes you wrote down in Step 1.

**Note:** Some TV/VCR combinations require a second code to control volume. If you cannot control volume, use the TV code from "TV/VCR Combinations" on Page 34.

## OPERATION

---

1. Press the device key for the device you want to control.
2. Point the remote control toward the device you want to control, then press the desired command keys.
3. Repeat Steps 1 and 2 for all other devices you want to operate.

**Note:** The command keys on the remote control work the same as the keys on the original remote control; however, the labeling might differ slightly.

4. To turn off the last device you selected, press **POWER**. To turn off other devices, press the device key for the device you want to turn off, then press **POWER**.

## CONVERTING DEVICE KEYS

You can use the 4-in-One Light-Up to operate a second TV or VCR (or other components) for a total of up to four devices. To do this, you must first convert an unused device key (**TV**, **VCR**, **CBL**, **AUX**) to operate each additional device. For example, to convert **AUX** to operate a second TV:

1. Hold down **P** until the red light blinks twice.
2. Press **9 9 2**. The red light blinks twice.
3. Press **TV**.
4. Press **AUX**. The red light blinks twice.
5. Program the converted device key (**AUX**) with the code for the second TV. (See "Setting Up Your Remote Control" on Page 6.)

Repeat these steps for each key you want to convert. To convert a key back to its original



---

function, repeat Steps 1–2, then press **AUX** twice.

## PUNCH-THROUGH

The punch-through feature lets you alternately control two different devices without pressing the device keys for each one.

A TV is often the only device that uses the volume keys. Punch-through allows you to control the TV's volume while the 4-in-One is in any device mode. With punch-through on, if you press **VCR** and use your volume keys, the 4-in-One will control the TV's volume instead of the VCR's.

### Turning Punch-Through Off /On

If your cable converter or VCR has volume control, you might want to turn off punch-through so you can use the cable converter's or VCR's volume instead of the TV's.

To turn off punch-through:

1. Hold **P** until the red light blinks twice.
2. Press **9 9 3** then **VOL +**. The red light blinks four times.
3. When you want to control the volume through your cable converter, press **CBL** before using the volume control.

To turn punch-through back on:

1. Hold down **P** until the red light blinks twice.
2. Press **9 9 3**, then the device key you want to control all volume (**TV**, for example). The red light blinks twice and the device you chose controls volume whenever you press a volume key on the 4-in-One.

---

---

## FAVORITE CHANNEL SCAN

You can use your remote control to scan through up to 10 of your favorite channels on your TV, VCR, or cable box.

**Note:** You can scan channels only for one device (TV, VCR, cable converter) at a time. You cannot set up a favorite channel list for another device until you clear the existing list.

1. Press the device key for the device key with the channels you want to program (**TV**, **VCR**, or **CBL**). The red light blinks.
2. Hold down **P** until the red light blinks twice, then press **9 9 6**.
3. Enter the channel number of the first channel you want to include in your favorite channel list. Then press **P**.

**Notes:**

- Precede a single-digit number with a 0 (for example, 01, 02, and so on).
  - If you enter a three-digit number, you do not need to press **P** after entering the number.
  - If your TV requires an ENTER key when entering a channel number, press **ENTER** after you enter the channel number.
4. Repeat Step 3 for other channels (up to 10) you want to include in your list. Then hold down **P** until the red light blinks twice.
  5. To scan through the favorite channel list, press the device key for the device you want to tune (**TV**, **VCR**, or **CBL**), then press **SCAN**. The remote control repeatedly scans through the favorite channel list,

---

stopping on each channel for about 3 seconds.



6. Press any key other than **SCAN** when you see a channel you want to watch. Scanning stops.

### Clearing Favorite Channel Scan

You must clear the channels in your favorite channel scan list if you want to change them.

1. Hold down **P** until the red light blinks twice.
2. Press **9 9 6**, then hold down **P** until the red light blinks twice.

### USING THE LIGHT

The back light lets you see the keys on your 4-in-One Light-Up in the dark. Press  to turn on the feature. Every time you press a key, the 4-in-One Light-Up lights and stays lit for a few seconds. To turn off the light, press  again.

## **IF YOU HAVE PROBLEMS**

---

### **MANUAL CODE SEARCH**

If the 4-in-One Light-Up Remote Control does not operate your remote-controlled devices when you first set it up, you might have to manually find the correct codes for your devices. You can try all the codes listed in "Manufacturer Codes" on Page 15 for your brand device, or you can follow these steps to search the remote control's entire library.

1. Manually turn on the device you want to set up.
2. Press the corresponding device key (**TV**, **VCR**, **CBL**, or **AUX**).
3. Hold down **P** until the red light blinks twice, then press **9 9 1**. The red light blinks twice again.
4. Aim the remote control at the device you want to operate.
5. Repeatedly press **POWER** then the device key (**TV**, **VCR**, **CBL**, or **AUX**) until the device turns off.
6. When the device turns off, press **P** within 10 seconds to save the code. The red light blinks twice.

**Note:** If you do not press **P** within 10 seconds, the remote control does not save the code.

- Because the 4-in-One's library has so many codes, this can take several minutes.
- If your device turns off during the search, but does not operate after you lock in the code, begin the search again, pausing longer between key presses.

If necessary, repeat these steps for each device.

---

---

**Note:** Some VCRs and CD players do not have a POWER key on the original remote. If so, manually turn on the VCR, insert a tape or CD, and repeat the manual code search using **PLAY** instead of **POWER**. When the device responds, press **P**. The red light blinks twice.

### Determining the 4-Digit Code

After you set up your remote control using the manual code search, you can find which 4-digit code the remote control is set to by following these steps.

1. Press the device key you want to get the manufacturer's code from, then hold down **P** until the red light blinks twice.
2. Press **9 9 0**. The red light blinks twice again.
3. Press **1**, then count the number of times the red light blinks. This is the first digit of the 4-digit code.

**Note:** If the red light does not blink, the digit is a **0**.

4. Repeat Step 3 three times to find the second, third, and fourth numbers of the 4-digit manufacturer's code, pressing **2**, **3**, and **4** respectively for each additional digit.

---

---

## TROUBLESHOOTING

If the remote control stops working after you have successfully tested the control for each device, or if you are unable to get the remote control to work at all:

- Be sure you press the device key for the device you want to control before you press any other key.
- Confirm that your remote-controlled devices are working properly by using the original remote control or the manual controls.
- Replace the batteries.
- If some keys do not function, try a different device code.
- Call **1-888-284-8735** for technical support.

## **MANUFACTURER CODES**

The following list tells you which 4-digit codes to enter to set up the remote control to operate your:

- Cable Converter (see Page 15)
- CD Player (see Page 17)
- Home Automation (see Page 20)
- Satellite Receiver (see Page 20)
- Television (see Page 21)
- TV/VCR Combination (see Page 34)
- VCR (see Page 28)
- Video Accessory (see Page 20)

### **Notes:**

- The remote control might not have every command from your original remote controls.
- Use the 4-in-One's label to record the manufacturers' codes for your remote-controlled devices.
- A key on the remote control that has the same name as a key on your original remote control might have a slightly different function.

<b>Manufacturer</b>	<b>Code(s)</b>	<b>RadioShack Cat. No.</b>
<b>Cable Converters</b>		
ABC	0003, 0008, 0014, 0017, 0007, 0011, 0013	
Allegro	0153, 0315	
Antronix	0022, 0207	
Archer	0153	16-1283
	0022	15-1285
	0207	16-1283
	0798	15-1288
Bell & Howell	0014	

<b>Manufacturer</b>	<b>Code(s)</b>	<b>RadioShack Cat. No.</b>
Cabletenna	0022	
Cableview	0022	
Century	0153	
Citizen	0153, 0315	
Colour Voice	0025	
Comtronics	0040	
Contec	0019	
Eastern	0002	
Emerson	0797	
Everquest	0015, 0040	
Focus	0400	
GC Electronics	0207	
Garrard	0153	
Gemini	0015	
General Instrument	0476, 0276, 0011, 0810	
GoldStar	0144, 0040	
Goodmind	0797	
Hamlin	0020, 0259, 0009, 0034	
Hitachi	0011	
Hytex	0007	
Jasco	0015, 0153, 0315	
Jerrold	0003, 0012, 0476, 0276, 0014, 0015, 0011, 0810	
Memorex	0000	
Movie Time	0063	
NSC	0063	
Oak	0019, 0007	
Optimus	0021	
Panasonic	0000, 0107, 0021	
Paragon	0000	
Philips	0153, 0025	
Pioneer	0144, 0533	
Popular Mechanics	0400	
Pulsar	0000	
Quasar	0000	



<b>Manufacturer</b>	<b>Code(s)</b>	<b>RadioShack Cat. No.</b>
RCA	0021	
RadioShack	0015, 0315, 0883, 0303	
	0797	15-1288
Realistic	0207	16-1283, 15-1285A
Recoton	0400	
Regal	0020, 0259	
Regency	0002	
Rembrandt	0011	
Runco	0000	
SL Marx	0040	
Samsung	0144, 0040	
Scientific Atlanta	0008, 0477, 0017	
Signal	0015, 0040	
Signature	0011	
Sprucer	0021	
Starcom	0003, 0015	
Stargate	0015, 0040, 0797	
Starquest	0015	
TV86	0063	
Tandy	0258	
Teleview	0040	
Tocom	0012, 0013	
Toshiba	0000	
Tusa	0015	
Unika	0153, 0022, 0207	
United Artists	0007	
Universal	0153, 0022, 0191, 0207	
Viewstar	0063, 0258	
Zenith	0000, 0525	
Zentek	0400	
<b>CD Players</b>		
ADC	0018	
Adcom	0155	
Aiwa	0157, 0124	
Audio Alchemy	0194	
Audio-Technica	0170	

---

---

<b>Manufacturer</b>	<b>Code(s)</b>	<b>RadioShack Cat. No.</b>
BSR	0194	
Burmester	0420	
California Audio Lab	0029	
Carrera	0194	
Carver	0157, 0179, 0437	
DKK	0000	
Denon	0003, 0873	
Emerson	0305, 0155, 0164, 0469	
Fisher	0179, 0174, 0342	
GE	0009	
Garrard	0420, 0393, 0280	
Genexxa	0032, 0305, 0164	
Goodmans	0363	
Harman/Kardon	0173, 0426	
Hitachi	0032, 0155	
JVC	0072	
Kenwood	0028, 0037, 0190, 0826, 0681	
Krell	0157	
Kyocera	0018	
LXI	0305	
Linn	0157	
MCS	0029	
MTC	0420	
Magnavox	0157, 0305	
Marantz	0029, 0157, 0180	
Mission	0157	
NSM	0157	
Nikko	0164, 0170, 0174	
Onkyo	0101	

---

<b>Manufacturer</b>	<b>Code(s)</b>	<b>RadioShack Cat. No.</b>
Optimus	0000, 0087, 0280, 0671	
	0032	31-3042, 42-5041, 42-5044,
	0179	13-1248, 14-545, 42-5015, 42-5049
	0305	42-5048, 42-5061
	0037	13-1251
	0420	31-3041, 42-5022, 42-5025, 42-5071
	0145	13-1258
	0468	42-5045, 42-5060, 42-5062, 42-5063, 42-5064
	0175	42-5013
	0194	42-5016
	0196	42-5019, 42-5032
	0342	42-5037
	0426	42-5031, 42-5036, 42-5038
	0437	42-5023, 42-5024
0536	13-1261, 13-1263	
0775	42-5059	
Panasonic	0029, 0367, 0752	
Parasound	0420, 0194	
Philips	0157	
Pioneer	0032, 0305, 0468, 0244	
Proton	0157	
QED	0157	
Quasar	0029	
RadioShack	0145	13-1259
RCA	0179, 0305, 0053, 0009, 0155, 0764	
Realistic	0179	42-5014
	0420	42-5022
	0155	42-5004, 42-5007
	0164	
	0175	42-5010
	0180	42-5020
	0452, 0453	

<b>Manufacturer</b>	<b>Code(s)</b>	<b>RadioShack Cat. No.</b>
Rotel	0157, 0420	
SAE	0157	
STS	0018	
Sansui	0157, 0305	
Sanyo	0179, 0087	
Scott	0305, 0155, 0164	
Sears	0305	
Sharp	0037, 0180	
Sherwood	0114, 0180, 0196, 0426	
Sony	0000, 0185, 0490, 0604, 0605	
Staron	0398	
Tascam	0420	
Teac	0420, 0393, 0174, 0180	
Technics	0029	
Vector Research	0194	
Victor	0072	
Wards	0157, 0053	
Yamaha	0036, 0170, 0187	
Yorx	0461	
<b>Home Automation</b>		
GE	0240	
One For All	0167	
RadioShack	0240	
Security System	0167	
Universal X10	0167	
X10	0167	
<b>Video Accessories</b>		
Archer	0160	
GC Electronics	0160	
Jebsee	0160	
RadioShack	0160	
<b>Satellite Receivers</b>		
AlphaStar	0772	
Chaparral	0216	
Echostar	0775	

<b>Manufacturer</b>	<b>Code(s)</b>	<b>RadioShack Cat. No.</b>
Expressvu	0775	
General Instrument	0627, 0361, 0869	
HTS	0775	
Hitachi	0819	
Hughes Network Sys- tems	0749	
JVC	0775	
Jerrold	0627, 0361	
Magnavox	0724, 0722	
Memorex	0724	
Next Level	0869	
Optimus	0724	16-2575
Panasonic	0701	
Philips	0724, 0722	
Primestar	0627, 0361	
RCA	0566	16-2530, 16-2531, 16-2539
	0143, 0855, 0392	
Sony	0639	16-2545
Star Choice	0869	
Toshiba	0790	
Uniden	0722	
Zenith	0856	
<b>Televisions</b>		
A-Mark	0003	
AOC	0030, 0019, 0003, 0185	
Abex	0032	
Admiral	0093	
Adventura	0046	
Aiko	0092	
Akai	0030	
Alaron	0179	
Ambassador	0177	
Ampro	0751	
Anam	0180	
Anam National	0055	
Archer	0003	

<b>Manufacturer</b>	<b>Code(s)</b>	<b>RadioShack Cat. No.</b>
Audiovox	0451, 0180, 0003, 0092, 0623	
Baysonic	0180	
Belcor	0019	
Bell & Howell	0154, 0016	
Bradford	0180	
Brockwood	0019	
Broksonic	0236, 0463, 0003	
CXC	0180	
Candle	0030, 0056, 0046	
Carnivale	0030	
Carver	0054	
Celebrity	0000	
Cineral	0451, 0092	
Citizen	0060, 0030, 0056, 0039, 0046, 0092, 0280	
Clairtone	0185	
Concerto	0056	
Contec	0180, 0185	
Craig	0180	
Crosley	0054	
Crown	0180, 0039	
Curtis Mathes	0047, 0054, 0154, 0051, 0451, 0093, 0060, 0030, 0145, 0056, 0016, 0039, 0166, 0466	
Daewoo	0451, 0019, 0039, 0092, 0623, 0624	
Daytron	0019	
Denon	0145	
Dumont	0017, 0019	
Dwin	0720, 0774	
Electroband	0000, 0185	

<b>Manufacturer</b>	<b>Code(s)</b>	<b>RadioShack Cat. No.</b>
Emerson	0154, 0236, 0463, 0180, 0282, 0178, 0019, 0179, 0039, 0177, 0185, 0280, 0623, 0624	
Envision	0030	
Fisher	0154, 0159	
Fujitsu	0179	
Funai	0180, 0179, 0171	
Futuretech	0180	
GE	0047, 0051, 0451, 0093, 0282, 0178, 0021, 0055, 0135	
Gibraltar	0017, 0030, 0019	
GoldStar	0030, 0019, 0056, 0032, 1078	
Gradiente	0053, 0056	
Grunpy	0180, 0179	
Hallmark	0178	
Harley Davidson	0179	
Harman/Kardon	0054	
Harvard	0180	
Hitachi	0145, 0056, 0032, 0151	
Infinity	0054	
Inteq	0017	
JBL	0054	
JCB	0000	
JVC	0053	
Janeil	0046	
KEC	0180	
KTV	0180, 0030, 0039, 085, 0280	
Kenwood	0030, 0019	
Kloss	0046	

<b>Manufacturer</b>	<b>Code(s)</b>	<b>RadioShack Cat. No.</b>
LG	0056	
LXI	0047, 0054, 0154, 0156, 0178	
Logik	0016	
Luxman	0056	
MEI	0185	
MGA	0150, 0030, 0178, 0019	
MTC	0060, 0030, 0019, 0056, 0185	
Magnavox	0054, 0030, 0179, 0020, 0096, 0187	
Majestic	0016	
Marantz	0054, 0030	
Matsushita	0250	
Megatron	0178, 0145, 0003	
Memorex	0154, 0250, 0150, 0056, 0016, 0178	
Midland	0047, 0017, 0051, 0039, 0032, 0135	
Minutz	0021	
Mitsubishi	0093, 0150, 0178, 0019	
Motorola	0093, 0055	
Multitech	0180	
NAD	0156, 0178, 0166	
NEC	0030, 0019, 0056	
NTC	0092	
Nikko	0030, 0178, 0092	
Noshi	0018	
Onwa	0180	



<b>Manufacturer</b>	<b>Code(s)</b>	<b>RadioShack Cat. No.</b>
Optimus	0154	13-1283
	0166	31-3031, 31-3033, 31-3038, 31-3040
	0250	
Optonica	0093, 0165	
Orion	0236, 0463, 0179	
Panasonic	0051, 0250, 0055	
Penney	0047, 0156, 0051, 0060, 0030, 0178, 0021, 0019, 0018, 0056, 0039, 0003, 0032, 0135	
Philco	0054, 0463, 0030, 0145, 0019, 0020, 0096	
Philips	0054	
Pilot	0030, 0019, 0039	
Pioneer	0166	
Portland	0019, 0039, 0092	
Prism	0051	
Proscan	0047	
Proton	0178, 0003, 0466	
Pulsar	0017, 0019	
Quasar	0051, 0250, 0165, 0055	
RCA	0047, 0051, 0093, 0019, 0018, 0090, 0135	

<b>Manufacturer</b>	<b>Code(s)</b>	<b>RadioShack Cat. No.</b>
RadioShack	0047, 0154, 0019, 0039	
	0165	16-232, 16-233, 16-236, 16-250, 16-260
	0180	16-252, 16-253, 16-262, 16-292
	0030	16-254, 16-255, 16-256, 16-265
	0178	16-256, 16-263, 16-268, 16-280, 16-289
	0056	16-288
	0032	16-230, 16-232, 16-233, 16-236, 16-250, 16-260
Realistic	0154	16-229, 16-261, 16-299
	0165	16-235, 16-235A, 16-251
	0180, 0030, 0178, 0039, 0032	
	0056	16-288
Rhapsody	0185	
Runco	0017, 0030, 0603	
SSS	0180, 0019	
Sampo	0030, 0039, 0032	
Samsung	0060, 0030, 0178, 0019, 0056, 0032	
Samsux	0039	
Sansei	0451	
Sansui	0463	
Sanyo	0154, 0159	
Scimitsu	0019	
Scotch	0178	
Scott	0236, 0180, 0178, 0019, 0179	

<b>Manufacturer</b>	<b>Code(s)</b>	<b>RadioShack Cat. No.</b>
Sears	0047, 0054, 0154, 0156, 0178, 0179, 0056, 0159, 0171	
Semivox	0180	
Semp	0156	
Sharp	0093, 0165, 0039	
Shogun	0019	
Signature	0016	
Simpson	0187	
Sony	0000	
Soundesign	0180, 0178, 0179	
Spectricon	0003	
Squareview	0171	
Starlite	0180	
Supre-Macy	0046	
Supreme	0000	
Sylvania	0054, 0030, 0020, 0096	
Symphonic	0171	
TMK	0178, 0056, 0177	
Tandy	0093, 0218	
Tatung	0055, 0003	
Technics	0051, 0250	
Technol Ace	0179	
Techwood	0051, 0056, 0003	
Teknika	0054, 0180, 0150, 0060, 0019, 0179, 0056, 0016, 0039, 0092	
Telefunken	0056	
Toshiba	0154, 0156, 0060	
Tosonic	0185	
Totevision	0039	
Vector Research	0030	
Victor	0053	

<b>Manufacturer</b>	<b>Code(s)</b>	<b>RadioShack Cat. No.</b>
Vidikron	0054	
Vidtech	0178, 0019	
Viking	0046	
Wards	0054, 0165, 0030, 0178, 0021, 0019, 0179, 0056, 0016, 0020, 0096	
White Westinghouse	0623, 0624	
Yamaha	0030, 0019	
Zenith	0017, 0016, 0092	
Zonda	0003	
<b>VCRs</b>		
Admiral	0048	
Adventura	0000	
Aiko	0278	
Aiwa	0037, 0000, 0307	
Akai	0041, 0061, 0106	
American High	0035	
Asha	0240	
Audiovox	0037	
Beaumarck	0240	
Bell & Howell	0104	
Broksonic	0184, 0121, 0209, 0002, 0295, 0479	
CCE	0072, 0278	
Calix	0037	
Canon	0035	
Capehart	0020	
Carver	0081	
Cineral	0278	
Citizen	0037, 0278	
Colt	0072	
Craig	0037, 0047, 0240, 0072, 0271	

<b>Manufacturer</b>	<b>Code(s)</b>	<b>RadioShack Cat. No.</b>
Curtis Mathes	0060, 0035, 0041, 0162	
Cybernex	0240	
Daewoo	0045, 0278, 0020, 0561	
Daytron	0020	
Denon	0042	
Dynatech	0000	
Electrohome	0037	
Electroponic	0037	
Emerex	0032	
Emerson	0037, 0184, 0000, 0121, 0043, 0209, 0002, 0278, 0036, 0061, 0068, 0208, 0212, 0295, 0479, 0561	
Fisher	0047, 0104, 0054, 0066	
Fuji	0035, 0033	
Funai	0000	
GE	0060, 0035, 0048, 0240, 0202	
Garrard	0000	
Go Video	0432, 0526	
GoldStar	0037, 0038, 0480	
Gradiente	0000, 0008	
HI-Q	0047	
Harley Davidson	0000	
Harman/Kardon	0081, 0038	
Harwood	0072, 0068	
Headquarter	0046	
Hitachi	0000, 0042, 0041, 0105	
JVC	0067, 0041, 0008	
Jensen	0041	
KEC	0037, 0278	
KLH	0072	

<b>Manufacturer</b>	<b>Code(s)</b>	<b>RadioShack Cat. No.</b>
Kenwood	0067, 0041, 0038	
Kodak	0035, 0037	
LXI	0037	
Lloyd's	0000, 0208	
Logik	0072	
MEI	0035	
MGA	0240, 0043, 0061	
MGN Technology	0240	
MTC	0240, 0000	
Magnasonic	0278	
Magnavox	0035, 0039, 0081, 0000, 0149, 0110	
Magnin	0240	
Marantz	0035, 0081	
Marta	0037	
Matsushita	0035, 0162, 0454	
Memorex	0035, 0039, 0162, 0268, 0299, 0307, 0047	
	0037	16-524, 16-706,
	0000	16-406, 16-410, 16-411, 16-517
	0048	16-531, 16-618, 16-622
	0046	16-529, 16-530
	0104	16-412, 16-523, 16-525, 16-526, 16-529, 16-530, 16-619, 16-620, 16-621, 16-623
	0240	16-533, 16-655
Minolta	0042, 0105	
Mitsubishi	0048, 0067, 0043, 0061	
Motorola	0035, 0048	
Multitech	0000, 0072	
NAD	0058	

<b>Manufacturer</b>	<b>Code(s)</b>	<b>RadioShack Cat. No.</b>
NEC	0104, 0067, 0041, 0038, 0040	
Nikko	0037	
Nikon	0034, 0253	
Noblex	0240	
Olympus	0035	
Optimus	0037	16-413, 16-419, 16-423, 16-534, 16-535, 16-624
	0048	16-538, 16-539, 16-540, 16-542, 16-543, 16-544, 16-546, 16-627, 16-628
	0104	16-536, 16-537, 16-617, 16-625, 13-1283
	0162	16-547, 16-548, 16-630, 16-631, 16-635, 16-640, 16-641, 16-642
	0454	16-547, 16-548, 16-630, 16-631
	0058	31-3023, 31-3031, 31-3032, 31-3033, 31-3037, 31-3038
	0240	16-541
	0432	16-541
	1162	
Optonica	0062	
Orion	0184, 0002, 0295, 0479	
Panasonic	0035, 0162, 0077, 0225, 0454, 1162	
Penney	0035, 0037, 0240, 0042, 0038, 0040, 0054	
Pentax	0042, 0105	
Philco	0035, 0209, 0479	
Philips	0035, 0081, 0062, 0110	

<b>Manufacturer</b>	<b>Code(s)</b>	<b>RadioShack Cat. No.</b>
Pilot	0037	
Pioneer	0067, 0058	
Portland	0020	
Profitronic	0240	
Proscan	0060, 0202	
Protec	0072	
Pulsar	0039	
Quarter	0046	
Quartz	0046	
Quasar	0035, 0162, 0077, 0454, 1162	
RCA	0060, 0035, 0048, 0240, 0042, 0149, 0077, 0105, 0106, 0202	
RadioShack	0000	16-417
	0307	16-706
Radix	0037	
Randex	0037	
Realistic	0035	16-472, 16-651, 16-705
	0037	16-408, 16-413, 16-414, 16-507, 16-534
	0047	16-506, 16-511, 16-512, 16-513, 16-515, 16-516, 16-518, 16-613, 16-614, 16-615, 16-652, 16-611, 16-612, 16-616, 16-653, 16-701, 16-702
	0000	16-404, 16-505, 16-508, 16-510, 16-519, 16-522, 16-703, 16-704
	0104	16-520, 16-521, 16-536, 16-563, 16-617
	0046	16-600, 16-601



<b>Manufacturer</b>	<b>Code(s)</b>	<b>RadioShack Cat. No.</b>
Realistic (continued)	0240	16-514
	0066	16-503
	0048, 0062	
Ricoh	0034, 0253	
Runco	0039	
STS	0042	
Samsung	0240, 0045	
Sanky	0048, 0039	
Sansui	0000, 0067, 0041, 0271, 0479	
Sanyo	0047, 0240, 0104, 0046, 0268	
Scott	0184, 0045, 0121, 0043, 0210, 0212	
Sears	0035, 0037, 0047, 0000, 0042, 0104, 0046, 0054, 0066, 0105	
Semp	0045	
Sharp	0048, 0062	
Shintom	0072	
Shogun	0240	
Singer	0072	
Sony	0035, 0032, 0000, 0033, 0034, 0253	
Sunpak	0253	
Sylvania	0035, 0081, 0000, 0043, 0110	
Symphonic	0000	
TMK	0240, 0036, 0208	
Tandy	0000, 0104	
Tatung	0041	
Teac	0000, 0041	
Technics	0035, 0162	
Teknika	0035, 0037, 0000	

<b>Manufacturer</b>	<b>Code(s)</b>	<b>RadioShack Cat. No.</b>
Thomas	0000	
Toshiba	0045, 0043, 0066, 0210, 0212	
Totevision	0037, 0240	
Unitech	0240	
Vector	0045	
Vector Research	0038, 0040	
Video Concepts	0045, 0040, 0061	
Videosonic	0240	
Wards	0060, 0035, 0048, 0047, 0081, 0240, 0000, 0042, 0072, 0149, 0062, 0212	
White Westinghouse	0278	
XR-1000	0035, 0000, 0072	
Yamaha	0038	
Zenith	0039, 0000, 0033, 0034	
<b>TV/VCR Combinations</b>		
Brocksonic	0002, 0479 (TV: 0463)	
Citizen	0278	
Colt	0072	
Curtis Mathes	0035 (TV: 0051)	
Daewoo	0278 (TV: 0624)	
Emerson	0002, 0278 (TV: 0624), 0479 (TV: 0463)	
Funai	0000	
GE	0240, 0035 (TV: 0051), 0048 (TV: 0093), 0060(TV: 0047)	

<b>Manufacturer</b>	<b>Code(s)</b>	<b>RadioShack Cat. No.</b>
Goldstar	0037 (TV: 0056)	
Harley Davidson	0000	
Hitachi	0000	
Lloyd's	0000	
Magnasonic	0278	
Magnavox	0000, 0081 (TV: 0054)	
Magnin	0240	
Memorex	0037, 1162	
MGA	0240	
Mitsubishi	0048 (TV: 0093)	
Optimus	1162	16-421, 16-422, 16-426, 16-427, 16-548, 16-631
Orion	0002, 0479 (TV: 0463)	
Panasonic	1162, 0035 (TV: 0051)	
RadioShack	0037	
RCA	0240, 0035 (TV: 0051), 0060 (TV: 0047), 0048 (TV: 0093)	
Sansui	0000, 0240, 0479 (TV: 0463)	
Sanyo	0240	
Sears	0000, 0037 (TV: 0056)	
Sharp	0048 (TV: 0093)	
Sony	0000, 0032 (TV: 0000)	
Sylvania	0081 (TV: 0054)	
Symphonic	0000	
Thomas	0000	
White Westinghouse	0278 (TV: 0624)	
Zenith	0000, 0479	

## CARE

---

---

To enjoy your 4-in-One Light-Up Remote Control for a long time:

- Keep the remote control dry. If it gets wet, wipe it dry immediately.
- Use and store the remote control only in normal temperature environments.
- Handle the remote control gently and carefully. Don't drop it.
- Keep the remote control away from dust and dirt.
- Wipe the remote control with a damp cloth occasionally to keep it looking new.

Modifying or tampering with the remote control's internal components can cause a malfunction and invalidate its warranty. If your remote control is not performing as it should, take it to your local RadioShack store for assistance.



# **SPECIFICATIONS**

Power ..... 4 AAA Batteries

IR Control Range ..... 26 ft ±30°

Dimensions (HWD) ..... 7<sup>1</sup>/<sub>4</sub> × 2<sup>1</sup>/<sub>8</sub> × 1<sup>1</sup>/<sub>4</sub> Inches  
(185 × 55 × 32 mm)

Weight (Without Batteries) .. 4.1 oz. (116 gm)

Specifications are typical; individual units might vary. Specifications are subject to change and improvement without notice.

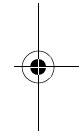
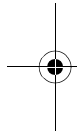



# NOTES

---

---

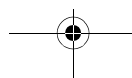
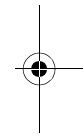
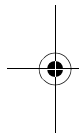

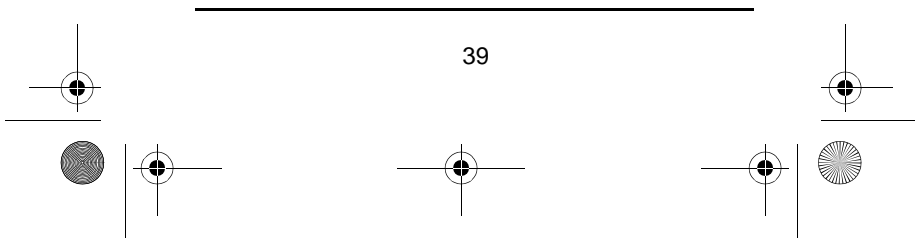
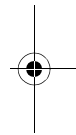
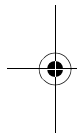
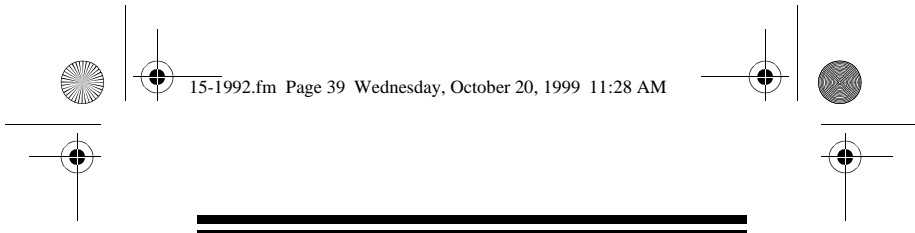

### Limited Ninety-Day Warranty

This product is warranted by RadioShack against manufacturing defects in material and workmanship under normal use for ninety (90) days from the date of purchase from RadioShack company-owned stores and authorized RadioShack franchisees and dealers. EXCEPT AS PROVIDED HEREIN, RadioShack MAKES NO EXPRESS WARRANTIES AND ANY IMPLIED WARRANTIES, INCLUDING THOSE OF MERCHANTABILITY AND FITNESS FOR A PARTICULAR PURPOSE, ARE LIMITED IN DURATION TO THE DURATION OF THE WRITTEN LIMITED WARRANTIES CONTAINED HEREIN. EXCEPT AS PROVIDED HEREIN, RadioShack SHALL HAVE NO LIABILITY OR RESPONSIBILITY TO CUSTOMER OR ANY OTHER PERSON OR ENTITY WITH RESPECT TO ANY LIABILITY, LOSS OR DAMAGE CAUSED DIRECTLY OR INDIRECTLY BY USE OR PERFORMANCE OF THE PRODUCT OR ARISING OUT OF ANY BREACH OF THIS WARRANTY, INCLUDING, BUT NOT LIMITED TO, ANY DAMAGES RESULTING FROM INCONVENIENCE, LOSS OF TIME, DATA, PROPERTY, REVENUE, OR PROFIT OR ANY INDIRECT, SPECIAL, INCIDENTAL, OR CONSEQUENTIAL DAMAGES, EVEN IF RadioShack HAS BEEN ADVISED OF THE POSSIBILITY OF SUCH DAMAGES.

Some states do not allow the limitations on how long an implied warranty lasts or the exclusion of incidental or consequential damages, so the above limitations or exclusions may not apply to you. In the event of a product defect during the warranty period, take the product and the RadioShack sales receipt as proof of purchase date to any RadioShack store. RadioShack will, at its option, unless otherwise provided by law: (a) correct the defect by product repair without charge for parts and labor; (b) replace the product with one of the same or similar design; or (c) refund the purchase price. All replaced parts and products, and products on which a refund is made, become the property of RadioShack. New or reconditioned parts and products may be used in the performance of warranty service. Repaired or replaced parts and products are warranted for the remainder of the original warranty period. You will be charged for repair or replacement of the product made after the expiration of the warranty period.

This warranty does not cover: (a) damage or failure caused by or attributable to acts of God, abuse, accident, misuse, improper or abnormal usage, failure to follow instructions, improper installation or maintenance, alteration, lightning or other incidence of excess voltage or current; (b) any repairs other than those provided by a RadioShack Authorized Service Facility; (c) consumables such as fuses or batteries; (d) cosmetic damage; (e) transportation, shipping or insurance costs; or (f) costs of product removal, installation, set-up service adjustment or reinstallation.

This warranty gives you specific legal rights, and you may also have other rights which vary from state to state.

RadioShack Customer Relations, 200 Taylor Street, 6th Floor, Fort Worth, TX 76102

*We Service What We Sell*

04/99

**RadioShack**  
**A Division of Tandy Corporation**  
**Fort Worth, Texas 76102**

10A99

Printed in Korea